

European Power-Semiconductor and Electronics Company GmbH + Co. KG

# Leistungsgleichrichterdioden Power Rectifier Diodes D 1809 N

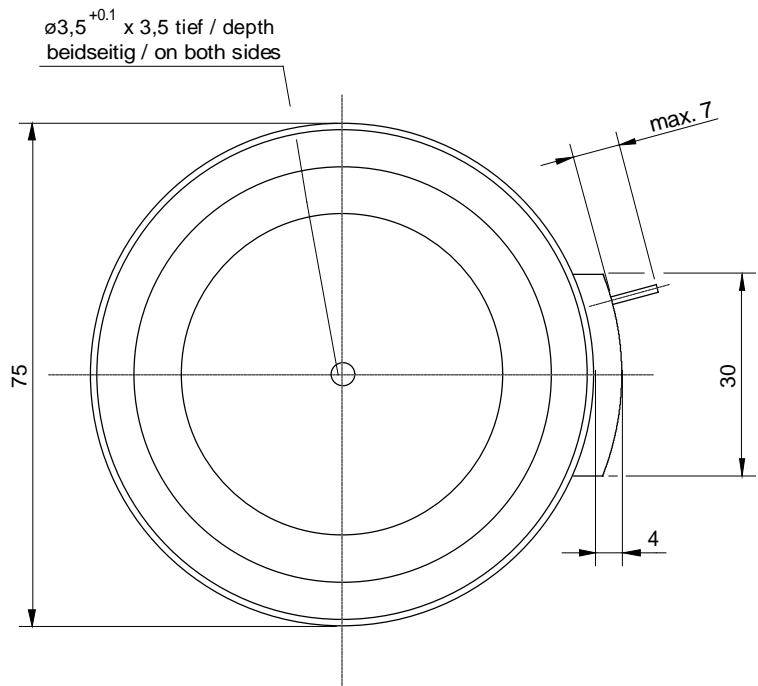
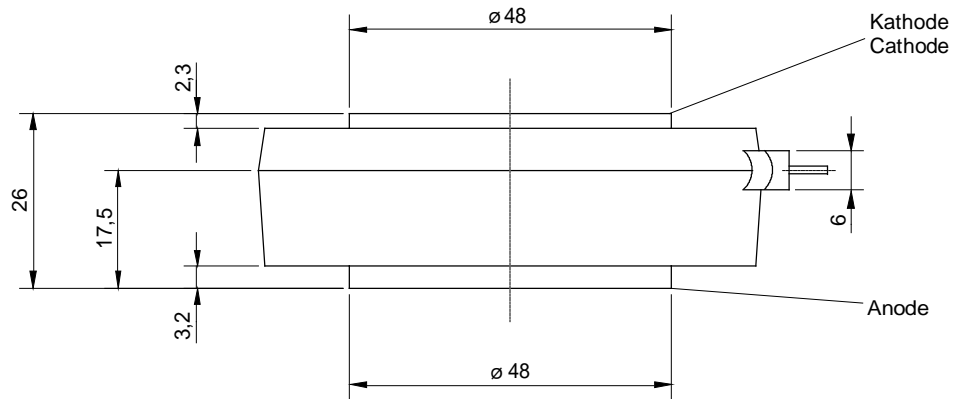

## D 1809 N

### Elektrische Eigenschaften

### Electrical properties

#### Höchstzulässige Werte

#### Maximum rated values

Periodische Spitzensperrspannung	repetitive peak reverse voltage	$t_{vj} = -40^{\circ}\text{C} \dots t_{vj \text{ max}}$	$V_{RRM}$	3200, 3600, 4000 4400, 4800	V V
Stoßspitzensperrspannung	non-repetitive peak reverse voltage	$t_{vj} = +25^{\circ}\text{C} \dots t_{vj \text{ max}}$	$V_{RSM} = V_{RRM}$	+ 100	V
Durchlaßstrom-Grenzeffektivwert	RMS forward current		$I_{FRMSM}$	3,85	kA
Dauergrenzstrom	mean forward current	$t_c = 100^{\circ}\text{C}$ $t_c = 61^{\circ}\text{C}$	$I_{FAVM}$	1,8 2,45	kA kA
Stoßstrom-Grenzwert	surge forward current	$t_{vj} = 25^{\circ}\text{C}, t_p = 10 \text{ ms}$ $t_{vj} = t_{vj \text{ max}}, t_p = 10 \text{ ms}$	$I_{FSM}$	35 275	kA <sup>1)</sup> kA
Grenzlastintegral	$I^2 t$ -value	$t_{vj} = 25^{\circ}\text{C}, t_p = 10 \text{ ms}$ $t_{vj} = t_{vj \text{ max}}, t_p = 10 \text{ ms}$	$I^2 t$	6125 3781	kA <sup>2</sup> s kA <sup>2</sup> s

#### Charakteristische Werte

#### Characteristic values

Durchlaßspannung	on-state voltage	$t_{vj} = t_{vj \text{ max}}, i_F = 7,4 \text{ kA}$	$V_T$	max.	2,82 V
Schleusenspannung	threshold voltage	$t_{vj} = t_{vj \text{ max}}$	$V_{T(TO)}$		0,85 V
Ersatzwiderstand	slope resistance	$t_{vj} = t_{vj \text{ max}}$	$r_T$		0,253 mΩ
Sperrstrom	reverse current	$t_{vj} = t_{vj \text{ max}}, V_R = V_{RRM}$	$i_R$	max.	100 mA

### Thermische Eigenschaften

### Thermal properties

Innerer Widerstand	thermal resistance, junction to case	beidseitig/two-sided, $\Theta = 180^{\circ} \text{ sin}$	$R_{thJC}$	max.	0,0169 °C/W
		beidseitig/two sided, DC		max.	0,0160 °C/W
		Anode/anode, $\Theta = 180^{\circ} \text{ sin}$		max.	0,0329 °C/W
		Anode/anode, DC		max.	0,0320 °C/W
		Kathode/cathode, $\Theta = 180^{\circ} \text{ sin}$		max.	0,0329 °C/W
		Kathode/cathode, DC		max.	0,0320 °C/W
Übergangs-Wärmewiderstand	thermal resistance, case to heatsink	beidseitig /two-sided	$R_{thCK}$	max.	0,0025 °C/W
		einseitig /single-sided		max.	0,0050 °C/W
Höchstzul.Sperrschichttemperatur	max. junction temperature		$t_{vj \text{ max}}$		160 °C
Betriebstemperatur	operating temperature		$t_{c \text{ op}}$		-40...+150 °C
Lagertemperatur	storage temperature		$t_{stg}$		-40...+150 °C

### Mechanische Eigenschaften

### Mechanical properties

Si-Element mit Druckkontakt	Si-pellet with pressure contact	$\varnothing = 58 \text{ mm}$			
Anpreßkraft	clamping force	Gehäuseform/case design T	F		24...60 kN
Gewicht	weight		G	typ.	540 g
Kriechstrecke	creepage distance				40 mm
Feuchteklasse	humidity classification	DIN 40040			C
Schwingfestigkeit	vibration resistance	$f = 50 \text{ Hz}$			50 m/s <sup>2</sup>
Maßbild	outline				Seite/page

<sup>1)</sup> Gehäusegrenzstrom 32 kA (50 Hz Sinushalbwellen) / Current limit of case 32 kA (50 Hz sinusoidal half-wave)

# D 1809 N

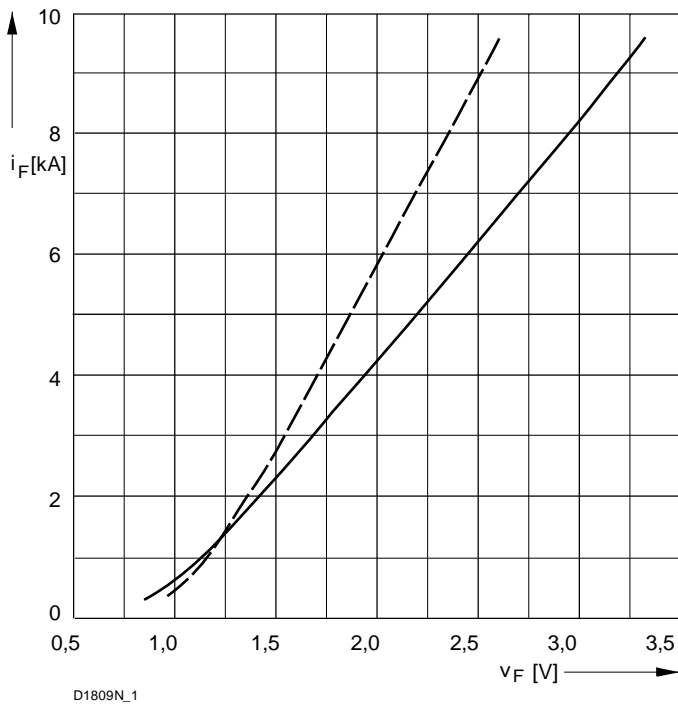

D1809N\_1

Bild/ Fig. 1  
Grenzdurchlaßkennlinie  
Limiting forward characteristic  $i_F = f(v_F)$   
—  $t_j = 160\text{ °C}$   
- - -  $t_j = 25\text{ °C}$

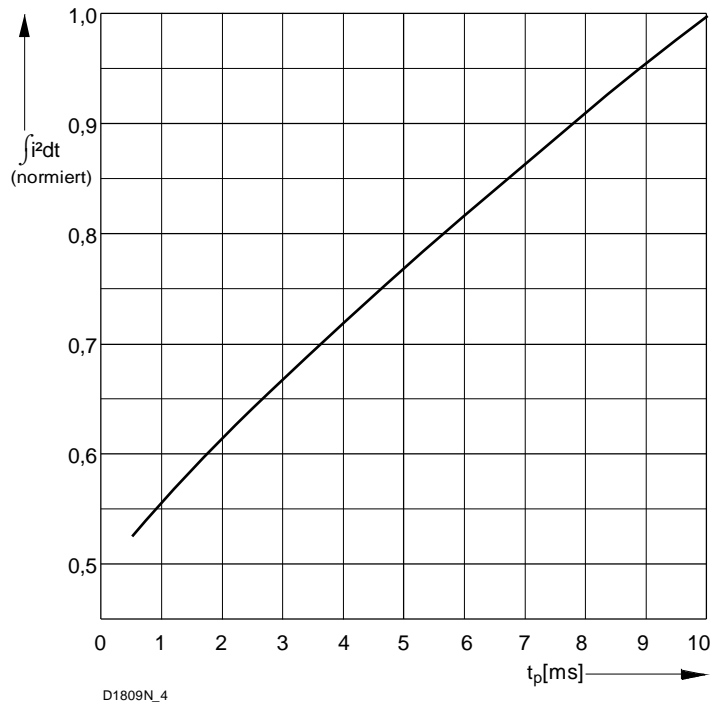

D1809N\_4

Bild / Fig. 2  
Normiertes Grenzlastintegral / Normalized  $i^2t$   
 $\int i^2 dt = f(t_p)$

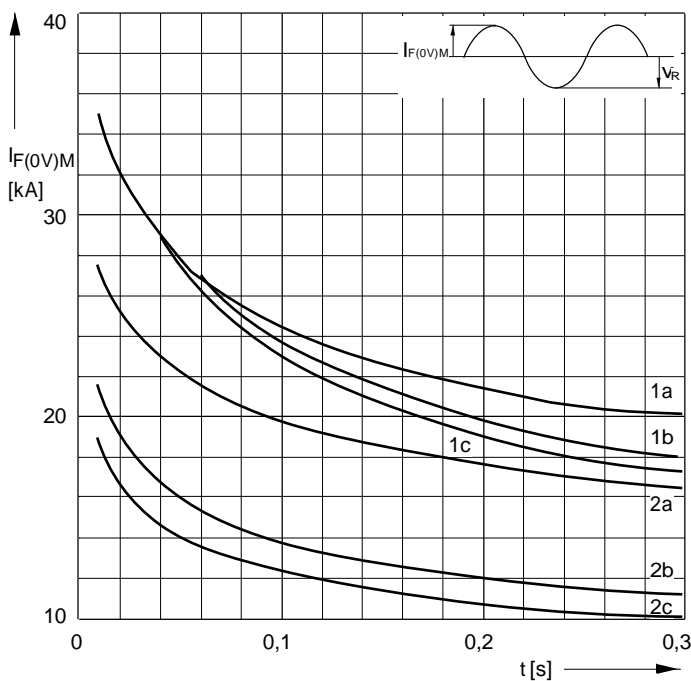

D1809N\_5

Bild / Fig. 3  
Grenzstrom / Maximum overload forward current  $I_{F(OV)M} = f(t)$   
1 -  $I_{FAV(vor)} = 0\text{ A}$ ;  $t_j = t_c = 25\text{ °C}$   
2 -  $I_{FAV(vor)} = 1800\text{ A}$ ;  $t_c = 100\text{ °C}$ ;  $t_j = 160\text{ °C}$   
a -  $v_R \leq 50\text{ V}$   
b -  $v_R = 0,5\text{ }V_{RRM}$   
c -  $v_R = 0,8\text{ }V_{RRM}$

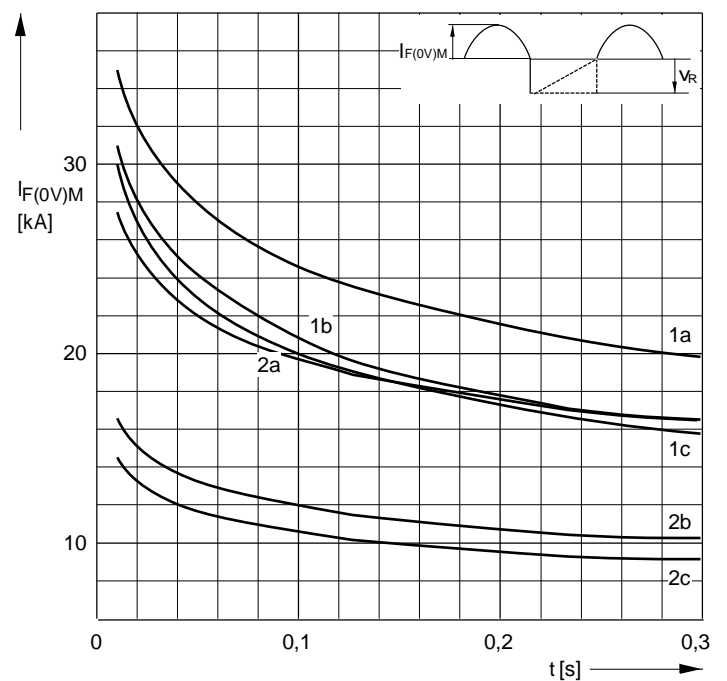

D1809N\_6

Bild / Fig. 4  
Grenzstrom / Maximum overload forward current  $I_{F(OV)M} = f(t)$   
1 -  $I_{FAV(vor)} = 0\text{ A}$ ;  $t_j = t_c = 25\text{ °C}$   
2 -  $I_{FAV(vor)} = 1080\text{ A}$ ;  $t_c = 100\text{ °C}$ ;  $t_j = 160\text{ °C}$   
a -  $v_R \leq 50\text{ V}$   
b -  $v_R = 0,5\text{ }V_{RRM}$   
c -  $v_R = 0,8\text{ }V_{RRM}$

# D 1809 N

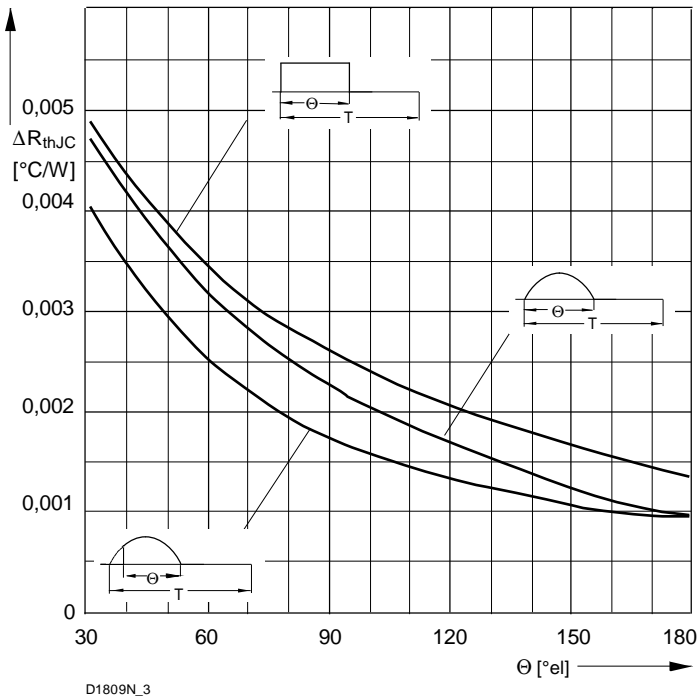

D1809N\_3

**Bild / Fig. 5**  
 Differenz zwischen den Wärmewiderständen für Pulsstrom und DC  
 Difference between the values of thermal resistance for pulse current and DC  
 Parameter: Stromkurvenform / Current waveform

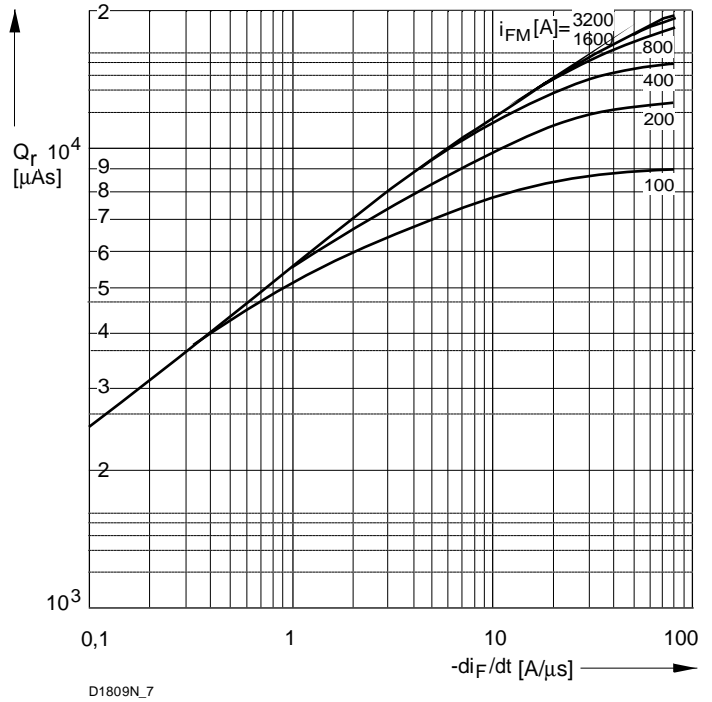

D1809N\_7

**Bild / Fig. 6**  
 Sperrverzögerungsladung / Recovered charge  $Q_r = f(-di_F/dt)$   
 $t_{vj} = t_{vjmax}$ ;  $V_R \leq 0,5 V_{RRM}$ ;  $V_{RM} = 0,8 V_{RRM}$   
 Beschaltung / Snubber:  $C = 1,5 \mu F$ ;  $R = 2,7 \Omega$   
 Parameter: Durchlaßstrom / Forward current  $i_{FM}$

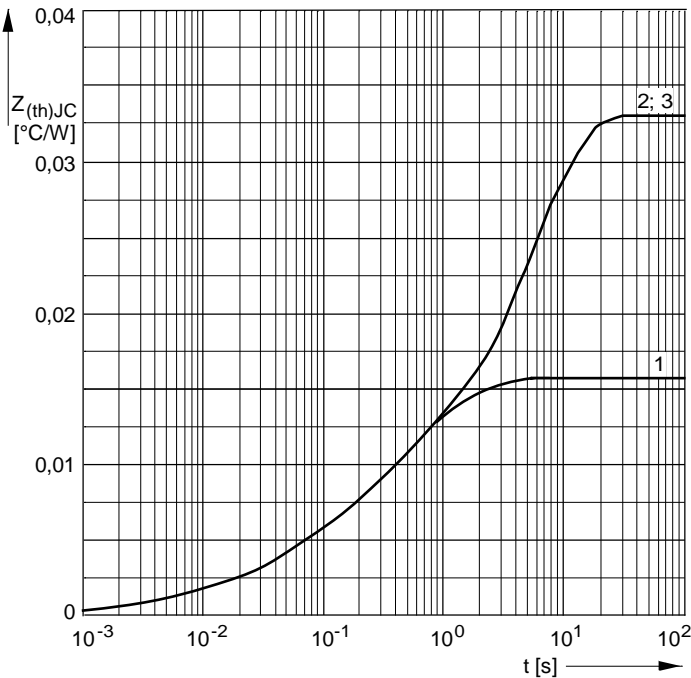

D1809N\_2

**Bild / Fig. 7**  
 Transienter innerer Wärmewiderstand  
 Transient thermal impedance  $Z_{thJC} = f(t)$ , DC  
 1 - Beidseitige Kühlung / Two-sided cooling  
 2 - Anodenseitige Kühlung / Anode-sided cooling  
 3 - Kathodenseitige Kühlung / Cathode-sided cooling

Analytische Elemente des transienten Wärmewiderstandes  $Z_{thJC}$  für DC  
 Analytical elements of transient thermal impedance  $Z_{thJC}$  for DC

Kühlg. Cooling	Pos. n	1	2	3	4	5	6	7
1	$R_{thn} \text{ } ^\circ C/W$	0,0000057	0,0004073	0,001107	0,00206	0,00503	0,00739	
	$\tau_{tn} [s]$	0,000184	0,00136	0,0108	0,0464	0,219	1,15	
2	$R_{thn} \text{ } ^\circ C/W$	0,000201	0,000849	0,00235	0,00567	0,00443	0,0185	
	$\tau_{tn} [s]$	0,000796	0,00533	0,0366	0,214	2,79	6,11	
3	$R_{thn} \text{ } ^\circ C/W$	0,000201	0,000849	0,00235	0,00567	0,00443	0,0185	
	$\tau_{tn} [s]$	0,000796	0,00533	0,0366	0,214	2,79	6,11	

- 1 - Beidseitige Kühlung / Two-sided cooling
- 2 - Anodenseitige Kühlung / Anode-sided cooling
- 3 - Kathodenseitige Kühlung / Cathode-sided cooling

Analytische Funktion / Analytical function

$$Z_{thJC} = \sum_{n=1}^{n_{max}} R_{thn}(1-EXP(-t/\tau_{tn}))$$